

CONTROLS
FOR
DOORS

COMMERCIAL HARDWARE

Architectural products inspired by design

Table Of Contents

Contents

Door Closers

08

Locks & Accessories

15

Cylinders

27

Panic Hardware

36

Door Handles

44

Access Control

51

Patch Fittings

56

Window Hardware

64

Cost – Effective



We pride ourselves on giving you the best prices on all the name brands.

High Quality Products

All our products are carefully selected to help ensure you get the best quality products at the right price.



Customer Support



Our team offer unrivalled technical support to help with any advise, issues or enquiries.

Next Day Delivery

Offering next day delivery on all stock items that are packaged securely and shipped safely to you.



About Us

Established in 1995, Controls for Doors Ltd has earned the reputation for supplying a broad range of high quality products, which offer ultimate field performance in terms of reliability and durability. The Controls for Doors product range offers both electronic and mechanical items which can be integrated to provide simple stand alone systems or more complex solutions, often containing bespoke elements.

The product range is backed by friendly and supportive customer service, aimed at providing both pre and post sales technical support. We welcome the opportunity to work with customers to provide solution based specifications. In order to provide this, we offer nationwide consultation.

Situated in Caterham, Surrey we are within easy reach of Junction 6 of the M25 and central London.

All The Known Brands





Our Finishes

- **PC** Polished Chrome
- **SC** Satin Chrome
- **PB** Polished Brass
- **BK** Black
- **WH** White
- **GR** Grey
- **SA** Satin Aluminium
- **S** Silver
- **G** Gold
- **SSS** Satin Stainless Steel
- **PSS** Polished Stainless Steel



Pull Handles

See page: 47



Transom Closers

See page: 9



Hook Locks

See page: 17



Euro Cylinders

See page: 31



Armsets

See page: 10



Bottom pivots

See page: 62

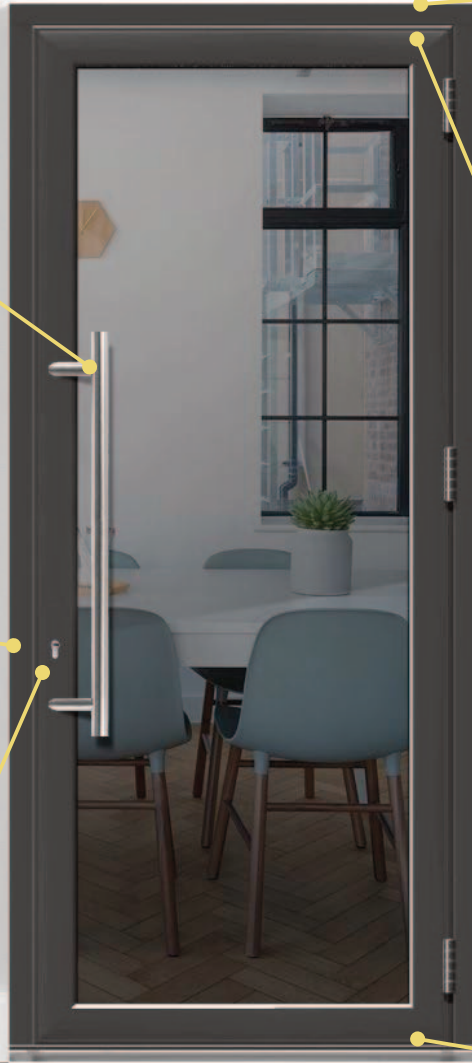

DOOR CLOSERS



Transom Door Closer



Features:

- Fixed power size 2/3/4
- Adjustable closing & latching speed
- Maximum door opening angle at 130°
- Mechanical hold-open 90°
- Concealed transom mount
- Complete with 65mm or 70mm fixing brackets & Fixings
- Extended spindle versions available in 5, 10 & 15mm
- Accessories are located on [page 10](#)

Application Ranges:

- Suitable for single & double doors
- Available for light, medium & heavy duty doors

DUTY	HOLD OPEN (HO)	NON HOLD OPEN (NHO)
LIGHT	CHL3718	CHL3717
MEDIUM	CHL1387	CHL2331
HEAVY	CHL3537	CHL2036
DUMMY	CHL1576	

POWER SIZE	2	3	4
Max. Door Width (mm)	900	1000	1100
Max. Door Weight (kg)	100		

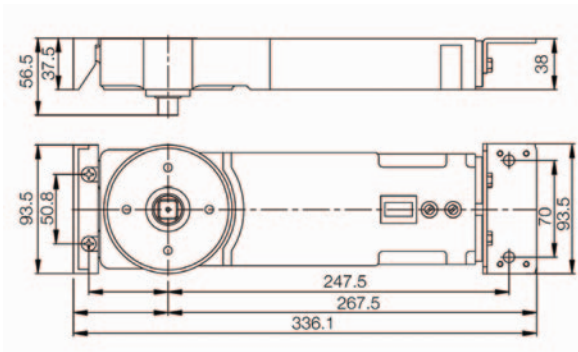

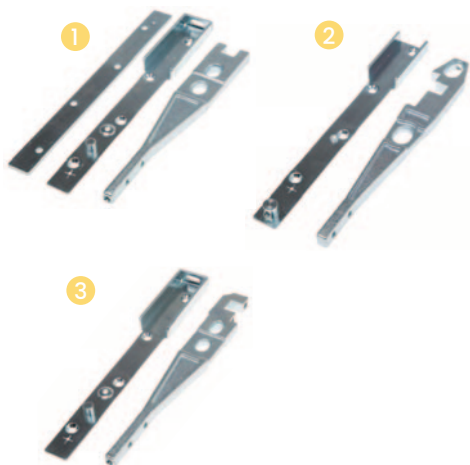

Arm Sets

Features:

- End load arm, standard side load arm & short side load arm
- Fully adjustable
- Hole and centre lines in channel for easy location of pivot point.
- Offering adjustment through hinge stile.
- All armsets are supplied complete with fixings blocks and tag plates

ARM SET	END LOAD 1	STANDARD SIDE LOAD 2	SHORT SIDE LOAD 3
PART CODE	CHL518	CHL3480	CHL1634



Bottom Pivots

Features:

- Standard
- Heavy duty
- RS10 Heavy duty
- All bottom pivots are supplied with fixings

BOTTOM PIVOT	STANDARD 1	HEAVY DUTY 2	RS10 HEAVY DUTY 3
PART CODE	CHL1021	CHL476	CHL3657



**Adjustable Power
Size 2-4 & 2-5**

FIG 1



Product Overview:

An efficient, durable and stylish variable power overhead door closer. Suitable for most applications particularly those with constant use which require a backcheck function.

Finishes:



SSS, S, PB

Testing & Standards:

- CE marked against EN1154
- Included in successful fire test to EN1634
- Suitable for use on timber fire doors of up to 120 minutes fire resistance.
- Safe in use
- High corrosion resistance

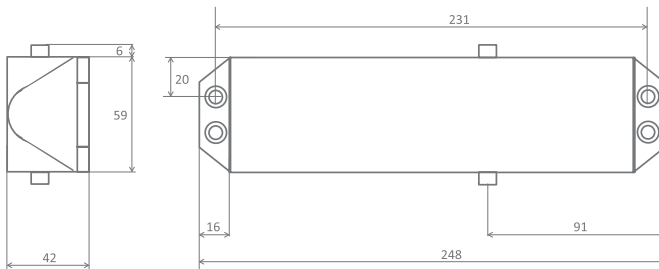

TYPE	SILVER	SATIN STAINLESS STEEL	POLISHED BRASS
2-4	CHL2406	CHL6066	CHL2502
2-5	CHL3617	CHL6140	CHL6141



Adjustable Power Size 2-4 Guide Rail

Product Overview:

A durable and stylish variable power overhead guide rail door closer. Suitable for a variety of applications where BS8300/Equalities Act/ Approved Document 'M' is not a requirement.

Features:

- CE marked against EN1154
- Included in successful fire test to EN1634
- Suitable for use on timber fire doors of up to 120 minutes fire resistance
- Safe in use
- High corrosion resistance

Finishes:

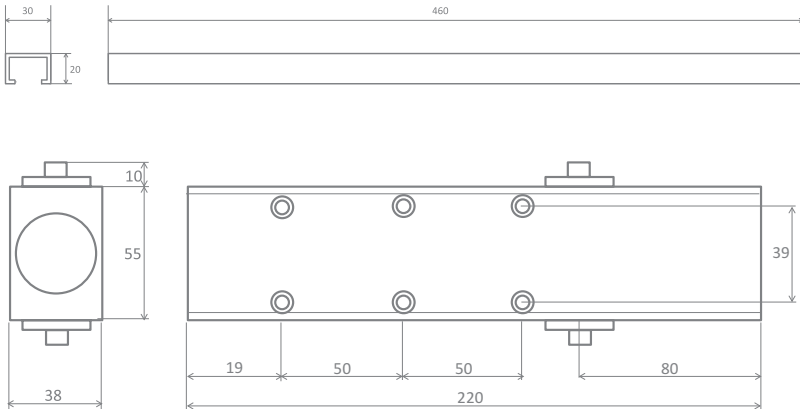

TYPE	SIZE 2-4
PART CODE	CHL3513



Universal Floor Spring

Features:

- Adjustable spring sizes
- Non-handed unit suitable for both single and double-acting doors
- Controlled closing with two independent values
- Single point hold open available at 90°
- Single point hold open available at 105°

Product Overview:

Offering adaptability to almost any installation. The closer's compact body permits its use where a larger closer would be prohibitive.

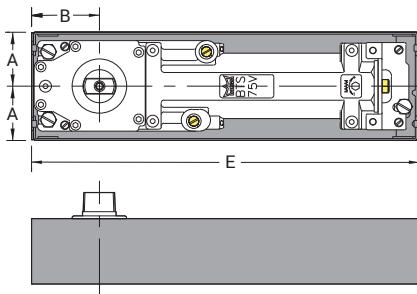

Cover plates sold separate

	A	B	C	D	E
Inches	1-7/16 – 1-13/16	2 – 2-1/4	2	3-1/4	11-1/4
Millimeters	36 – 46	51 – 57	51	82	285

TYPE	HOLD OPEN (HO) 90	NONE HOLD OPEN(NHO) 00	COVER PLATE SSS
PART CODE	CHL4342	CHL1034	CHL1035



Heavy Duty Universal Floor Spring

Product Overview:

Offers the perfect combination between freedom of creation and greatest reliability by their concealed floor mounting, providing a multitude of functions at the same time.

Features:

- Adjustable spring sizes
- Non-handed unit suitable for both single and double-acting doors
- Controlled closing with two independent values
- Single point hold open available at 90°
- Single point hold open available at 105°

1. Closing speed adjustment valve
2. Latching speed adjustment valve
3. Plug connector with cable for EMB & FLB power supply



Cover plates sold separate

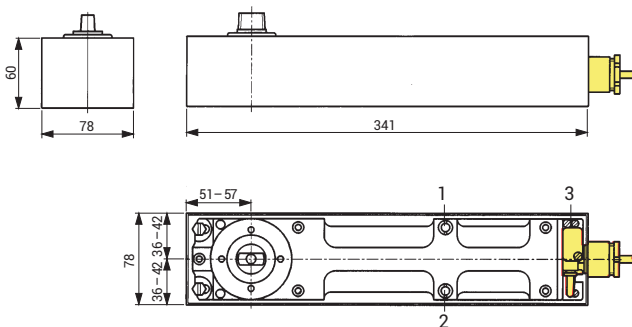

TYPE	BTS80	COVER PLATE SSS
PART CODE	CHL1592	CHL1433

LOCKS & Accessories





**Round cylinder
Hook Lock**

Features:

- Steel case with corrosion resistance
- Bolt throw 19mm
- Lock bolt 34.9mm x 20.6mm
- Complete with faceplate
- Round cylinders come separate

Backset Options:

- 28.6mm backset
- 38.1mm backset

**Mortice hook lock accessories
on page 22 & 23**

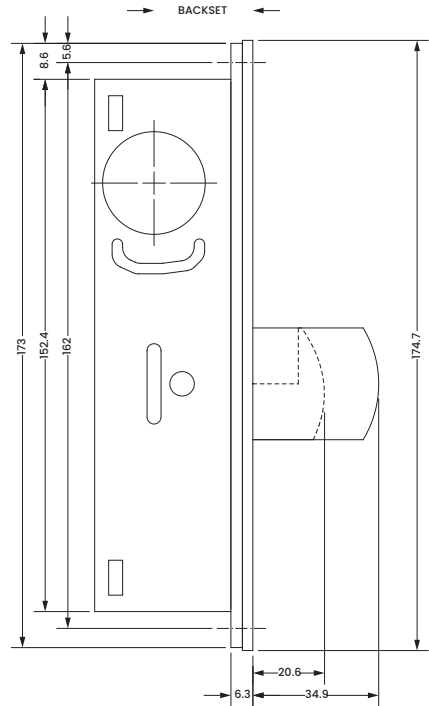

ROUND CYLINDER HOOKLOCK	28.6MM BACKSET	38.1MM BACKSET
PART CODE	CHL7446	CHL6142



Euro Profile Hook Lock

Features:

- Steel case with corrosion resistance
- Bolt throw 19mm
- Lock bolt 34mm x 12.5mm
- Complete with faceplate
- Round cylinder available

Backset Options:

- 25mm backset
- 30mm backset
- 40mm backset

Mortice hook lock accessories
on page 23 & 24

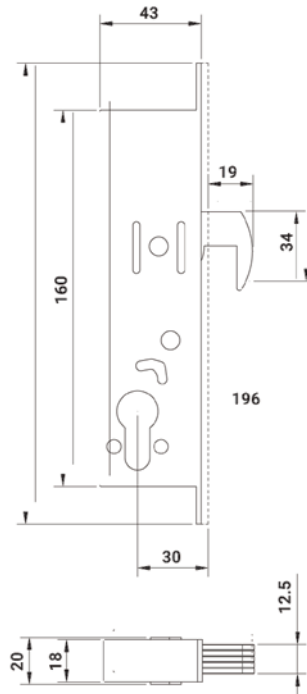

EURO PROFILE HOOKLOCK	25MM BACKSET	30MM BACKSET	40MM BACKSET
PART CODE	CHL3720	CHL3880	CHL3567

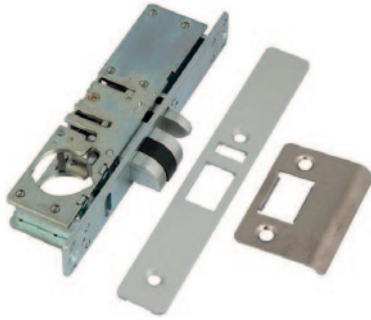

Round Cylinder Deadlatch

Case size & backset vary depending on version:

Backset Options:

- 25mm (31/32") backset
- 28mm (1-1/8") backset
- 38mm (1-1/2") backset

Case:

Steel with corrosion resistant plating.

Latchbolt:

Fully reversible latchbolt - without the need to open the case. Latchbolt complete with Hardened Steel Internal Pins

Faceplate:

173.5 x 25mm
Aluminium Material,
Finish: Matt/Satin Anodised Aluminium
Complete With: Flat Faceplate and Strikeplate

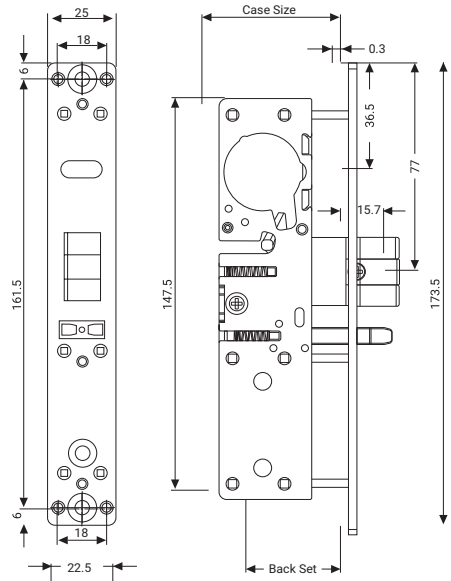

ROUND CYLINDER DEADLATCH	25MM BACKSET	28MM BACKSET	38MM BACKSET
PART CODE	CHL4120	CHL3765	CHL5897

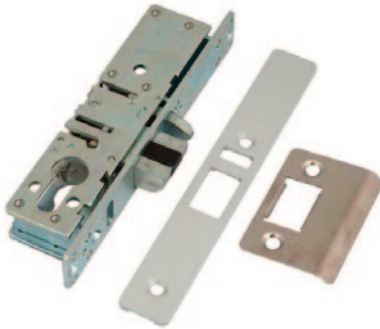

**Euro Profile
Deadlatch**

Backset Options:

- 25mm (31/32") backset
- 28mm (1-1/8") backset
- 38mm (1-1/2") backset

Case:

Steel with corrosion resistant plating.

Latchbolt:

Fully reversible latchbolt -
without the need to open the case.
Latchbolt complete with Hardened Steel
Internal Pins

Faceplate:

173.5 x 25mm
Aluminium Material,
Finish: Matt/Satin Anodised Aluminium
Complete With: Flat Faceplate and Strikeplate

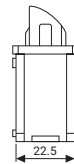

Case size & backset vary depending on version:

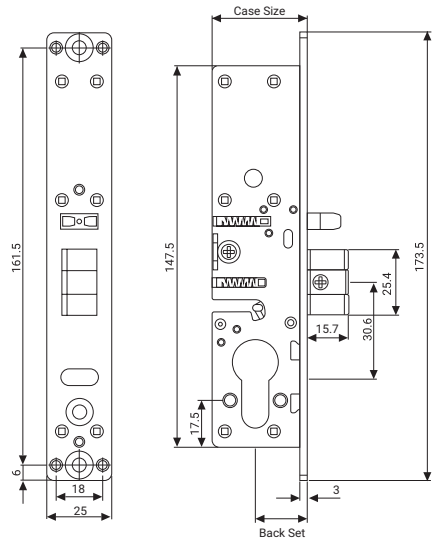

EURO PROFILE DEADLATCH	25MM BACKSET	28MM BACKSET	38MM BACKSET
PART CODE	CHL3878	CHL2405	CHL5897



Narrow-Style Sash Lock

Features:

- For European profile cylinder.
- Key action on latch bolt.
- Single throw dead bolt.
- Easy reversible latch bolt.
- Backset 30, 35, 40 and 45 mm.
- Distance 92 mm.
- U-forend on request.
- Forend stainless steel.
- Dead and latch bolt die-cast bright nickel-plated.
- Without strike plate.
- Latch, Anti-Panic, Nightlatch versions available

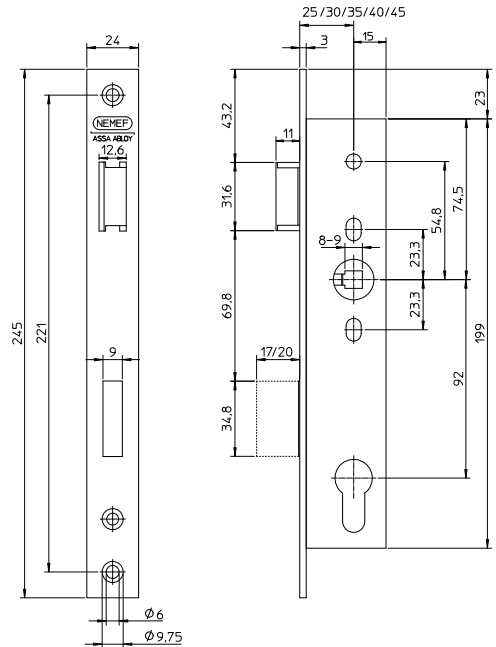

Suitable for inner & entrance doors.

BACKSET	30MM	35MM	40MM	45MM
PART CODE	CHL9602	CHL4780	CHL3899	CHL9603



High Security Hooklock

Features:

- Complies with BS EN 12209 at security grade 6
- Bolt withstands 10kN side load in unsupported application and 6kN end load
- Barbolt with anti-spread feature incorporating the benefits of hookbolt
- Enclosed mechanism prevents potential for tampering while under attack
- Specifically designed to fit into thermally broken and shopfront applications. Backset options – 25mm, 30mm & 40mm

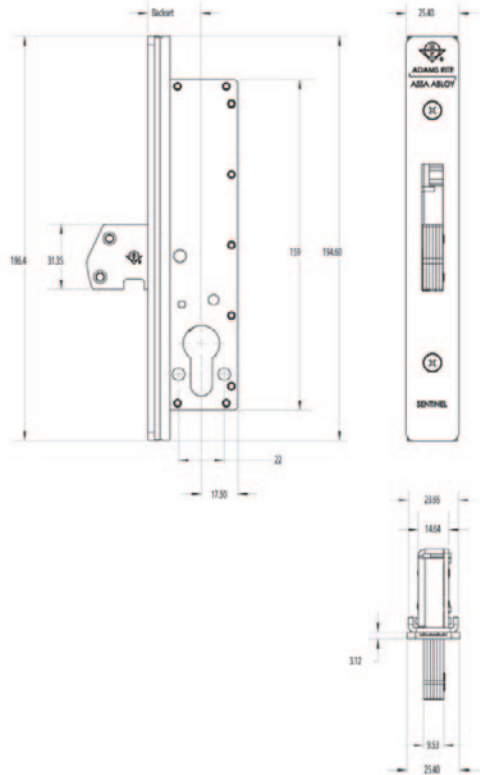

Trim Plate & Armoured Strike



Escutcheon

TYPE	25MM BACKSET	30MM BACKSET	40MM BACKSET	FLAT FACEPLATE	TRIM PLATE SAA	ARMOURD STRIKE	ESCUTCHEON
PART CODE	CHL3573	CHL3652	CHL3896	CHL3572	CHL4237	CHL4236	CHL3826

Locks

ACCESSORIES

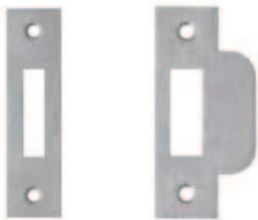

Dead & Latch Strike

Features:

- Complete with fixings
- To suit narrow style sashlocks
- For double door applications

PART CODE

CHL2184

CHL2183



Extended Strike Plate

Features:

- Complete with fixings
- To suit narrow style sashlocks
- For single door applications

PART CODE

CHL3638

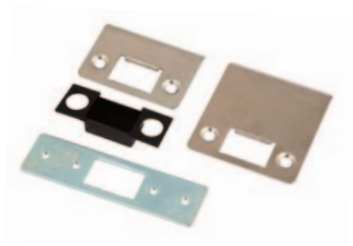

Extended Jaw Strike Plate

Features:

- To suit Euro profile or round cylinder hooklocks
- Complete with fixings

PART CODE

CHL2185



Euro Finger Pull

Features:

- Cylinder latch pull
- Complete with fixings
- 88mm x 43mm

PART CODE

CHL125



Mounting Bridges

Features:

- Sold as pairs
- Complete with fixings
- To suit round and Euro profile hooklocks

PART CODE CHL1240



Fixing Kits

Features:

- Deadlatch fixing kit
- Complete with fixings
- To suit round and Euro profile deadlatches

PART CODE CHL3648



Trim Plate

Features:

- To suit armoured strike plate
- Complete with fixings
- Available as flat or radius profile

PART CODE CHL3647



Armoured Strike Plate

Features:

- To suit Euro profile or round cylinder hooklocks
- Complete with fixings

PART CODE CHL3646

Squared Flush Bolt



Features:

- 130 x 26mm
- Square profile
- With anti-rattle sleeve
- Hardend steel bolt
- Complete with fixings

TYPE	FLAT FACEPLATE
PART CODE	CHL3735

Radius Flush Bolt



Features:

- Zinc plated with anti-rattle sleeve
- 7mm zinc plated steel rod with 40mm thread length
- Deep finger recess and large lever for easy operation
- Corners 2.5mm radius for easy matching of cut out
- Comes complete with guide

TYPE	FLAT FACEPLATE	RADIUS FACEPLATE	GUIDES ONLY
PART CODE	CHL3615	CHL3613	CHL3614

Locks

PAD HANDLES

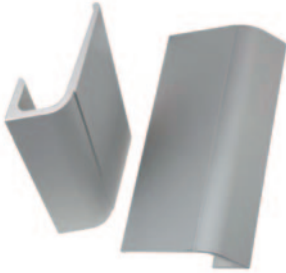

Aluminium Pad Handle

Features:

- The perfect set choice for commercial aluminium doors
- Complete with all the required fixings
- Height of 230mm or 300mm

Finishes:



SA, WH, BK

FINISH	SAA 230MM	SAA 300MM	WHITE 230MM	WHITE 300MM	BLACK 230MM	BLACK 300MM
PART CODE	CHL1165	CHL3756	CHL3562	CHL6147	CHL6143	CHL7221



Paddle Handle & Cam Plug

Features:

- for use with round cylinder deadlatches
- Suits 44mm thick doors
- Cam plug non-handed - reversible
- Suitable for aluminium and steel doors

Finishes:  SA

PART CODE **CHL3766**



Lever Handle & Cam Plug

Features:

- Suits 44mm thick doors
- Cam plug non handed - reversible
- Suitable for aluminium and steel doors

Finishes:  SA

PART CODE **CHL3419**



Adjustable Top Centre

Features:

- Top centre for double action doors
- Complete with fixing screws
- Centre of pivot 50 mm from end of plate

PART CODE CHL3634

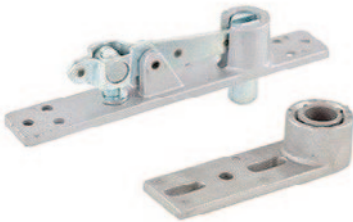

Light Duty Top Centre

Features:

- Material Die Cast
- Comes with Bottom Pivot

PART CODE CHL3753



Double Action Door Strap

Features:

- Drop forged steel construction
- Zinc plated
- Suitable for door weights up to 300kg
- Non-handed

PART CODE CHL7421

A range which comprises of single, double & turn cylinders with euro & oval bodies. Keyed to differ, keyed alike or master keyed versions are available.

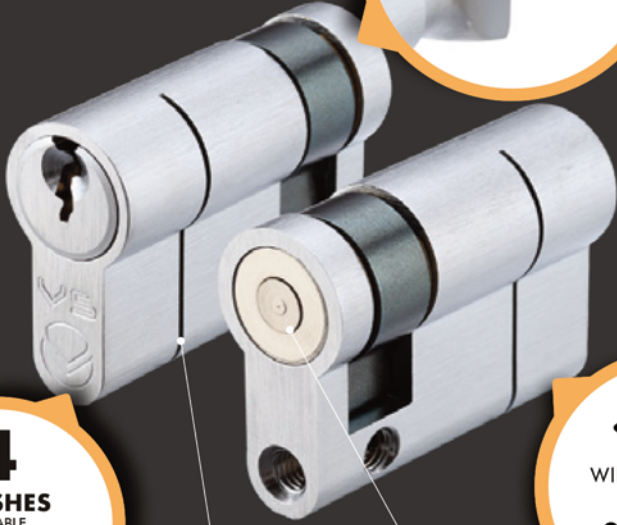

Break-off system

Adjustable CAM



We offer our own bespoke cylinder keying service

T: 01883 652652 F: 01883 652055 E: sales@cfdltd.com

CYLINDERS KEYING GUIDE

KEYED TO DIFFER

Each lock is opened by its own unique key, which does not open any other lock.

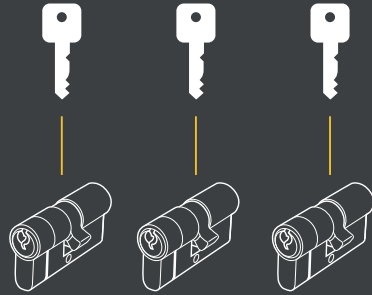

KEYED ALIKE

All cylinders in the set are opened by the same key, this option provides same key convenience and eliminates the need for multiple keys where numerous cylinders are used.

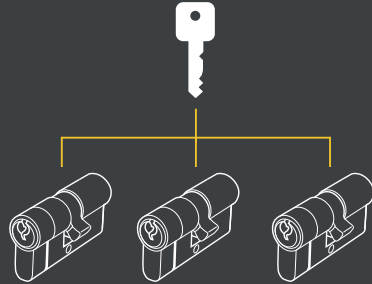

UNDER MASTER KEY

Where all cylinder locks are opened by a single master key then each of the cylinder locks are opened by their own key, often referred to as the slave, change or differ keys.

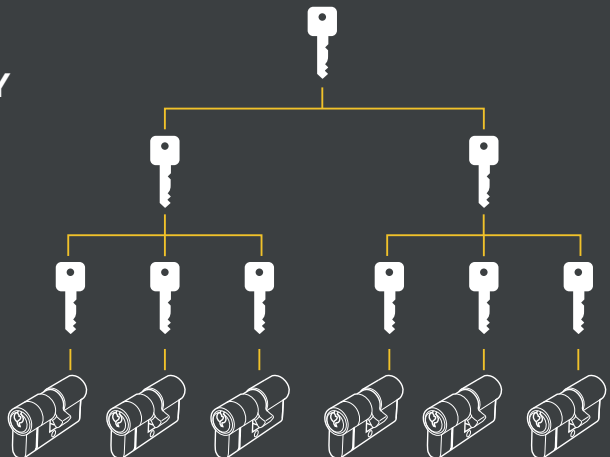

Cylinders

How To Measure a Cylinder

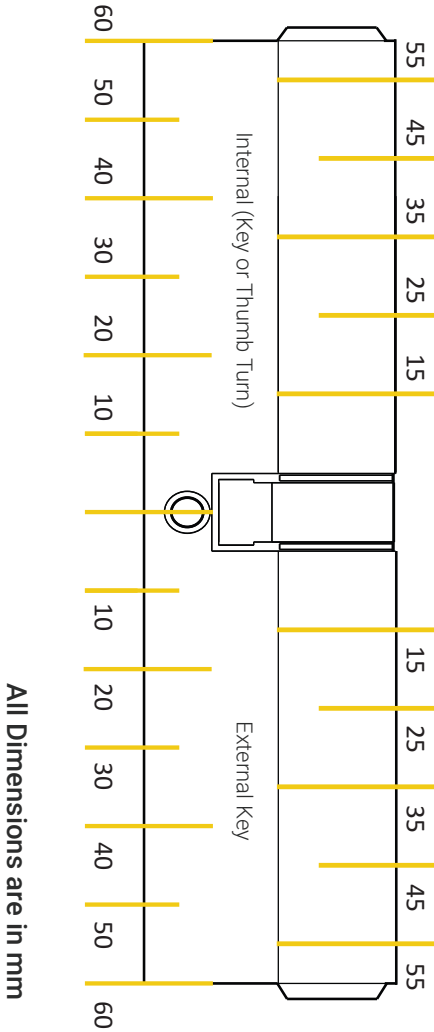

All Dimensions are in mm

CYLINDER STANDARDS



Cylinders

EURO PROFILE



Finishes:



SC, PB, BK, PC

Standards:



Euro Single Cylinder

Features:

- BS EN 1303
- BS EN 1634-1
- Anti-drill, Anti-pick & Anti-snap
- Adjustable cam
- Complete with 3 keys & fixing pin
- Full range of sizes available

All product codes for cylinders
can be found on page 35



Finishes:



SC, PB, BK, PC

Standards:



Euro Double Cylinder

Features:

- BS EN 1303
- BS EN 1634-1
- Anti-drill, Anti-pick & Anti-snap
- Complete with 3 keys & fixing pin
- Full range of sizes available
- Offset sizes available

Cylinders

EURO PROFILE



Finishes:



SC, PB, BK, PC

Standards:



Euro Cylinder & Turn

Features:

- BS EN 1303
- BS EN 1634-1
- Anti-drill, Anti-pick & Anti-snap
- Complete with 3 keys & fixing pin
- Full range of sizes available
- Offset sizes available

All product codes for cylinders can be found on page 35



3 Star Euro Cylinder

Features:

- Sold Secure Gold cylinder standard
- Anti-Bump mechanism
- Tested to British standard TS007:3
- 10 Year £1,000 protected guarantee
- Dual finish

Finishes:



SC/PB



Cylinders

EURO PROFILE



3 Star Cylinder

For pricing on the 3 star high security please contact a member of the team

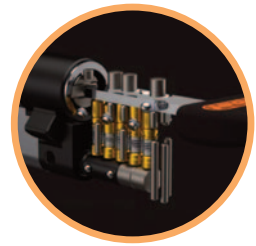

Profile Options:

- Half (single) cylinder
- Double cylinder
- Thumbturn cylinder

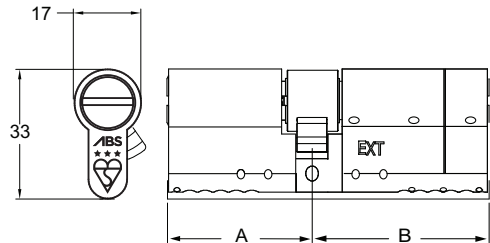

Features:

- SS312 Sold Secure Diamond Grade
- 3 Star British Kitemark - TS007:2014 (KM 586135)
- Secured by Design Accredited (Police preferred specification)
- Patented Snap Secure Technology
- Pick, Drill & Bump Resistant
- Pin-in-Pin and magnetic pin technology
- 6 Trap Pins for advance pick resistance
- 16 Anti-drill pins
- Double, single and thumbturn formats available
- Three keys per cylinder
- Secure online key registering
- Keyed alike key/key pairs are available ex stock
- Key alike with ABS Euro cylinders, Rim cylinders & padlocks



Finishes:



PC, PB



Cylinders

RIM CYLINDERS

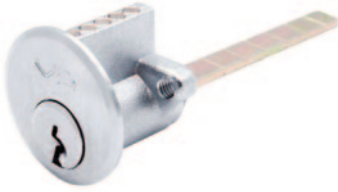

Rim Cylinder

Features:

- BS EN 1303
- BS EN 1634-1
- Anti-drill & Anti-pick
- Complete with 3 keys & trim ring

Finishes:



Standards:



SIZE	RIM CYLINDER KA	RIM CYLINDER KTD
PART CODE	CHL1024	CHL067



Threaded Rim Cylinder

Features:

- BS EN 1303
- BS EN 1634-1
- Anti-drill & Anti-pick
- Complete with 3 keys & trim ring
- Available as - KA, KTD & MK
- Extended versions are available

Finishes:



Standards:



TYPE	ROUND SCREW IN THUMBTURN	SCREW IN CYLINDER KA (Keyed Alike)	SCREW IN CYLINDER KTD (Keyed To Differ)
PART CODE	CHL3734	CHL3612	CHL1754

Cylinders

Cylinder Part Codes

All codes below are for Satin Chrome (SC) finishes

TYPE	SIZE	SINGLE	DOUBLE	CYLINDER & TURN
KA	40MM	CHL532	-	-
KTD	40MM	CHL530	-	-
KA	45MM	CHL536	-	-
KTD	45MM	CHL027	-	-
KA	50MM	CHL498	-	-
KTD	50MM	CHL537	-	-
KA	55MM	CHL028	-	-
KTD	55MM	CHL541	-	-
KA	60MM	-	CHL892	CHL058
KTD	60MM	-	CHL499	CHL342
KA	70MM	-	CHL894	CHL033
KTD	70MM	-	CHL557	CHL055
KA	80MM	-	CHL056	CHL607
KTD	80MM	-	CHL501	CHL343
KA	90MM	-	CHL910	CHL389
KTD	90MM	-	CHL502	CHL344
KA	100MM	-	CHL889	CHL390
KTD	100MM	-	CHL558	CHL356

For offset sizes and other finishes, please contact a member of our team.

T: 01883 652652 F: 01883 652055 E: sales@cdf ltd.com

PANIC HARDWARE



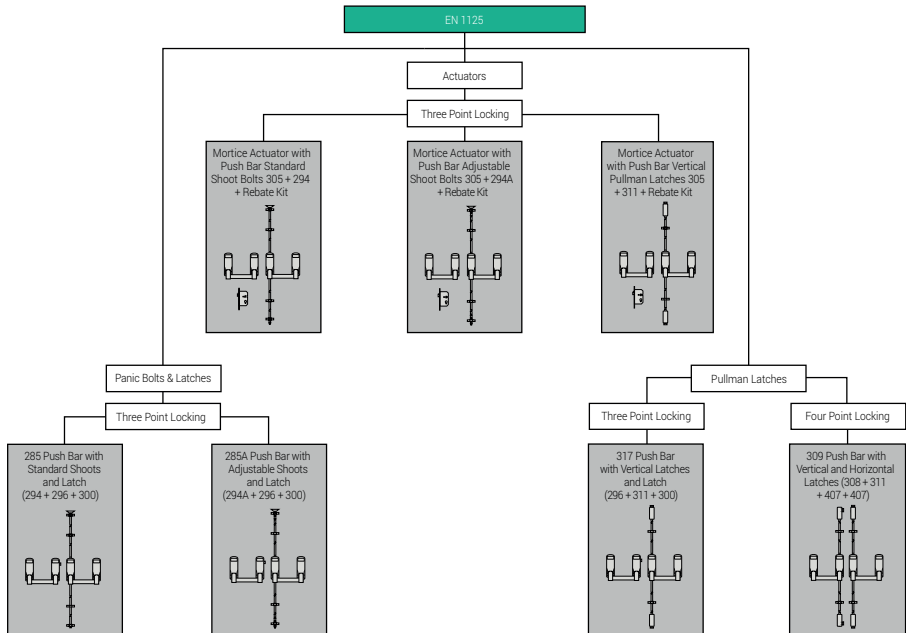
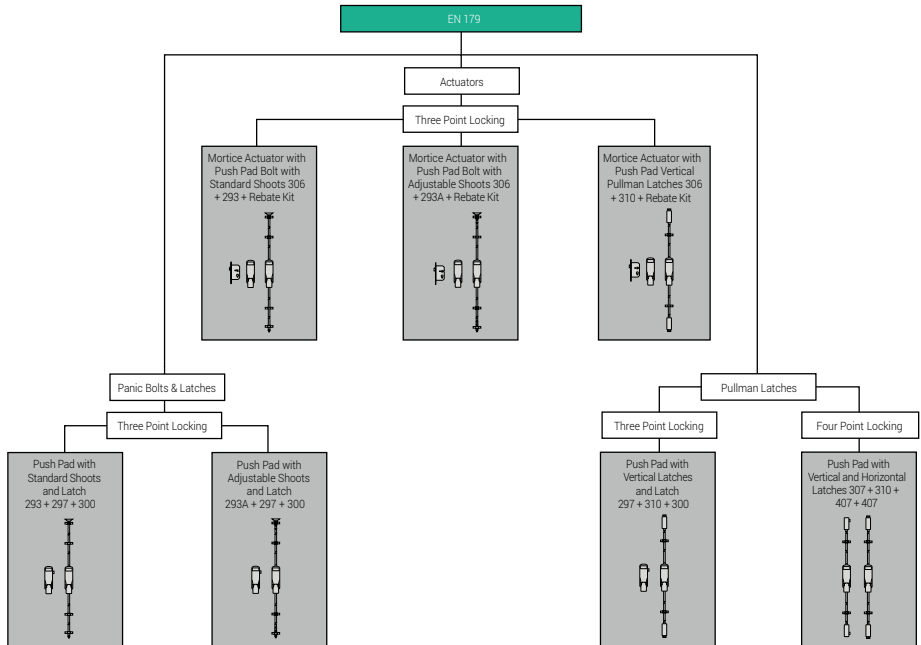



**Concealed Rod
Paddle Handle**

Features:

- Emergency device installed to the opening jamb
- Push paddle handle with engraved "PUSH"
- Compliant to BS EN 179
- Finished in Satin Chrome
- Operating paddle handle and lever do not exceed
- 120 mm x 186 mm projection
- Standard mortise rim cylinder lock available as option

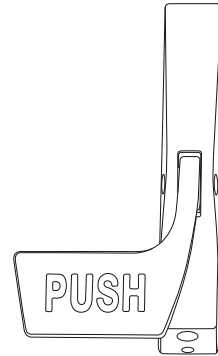

HAND OF DOOR

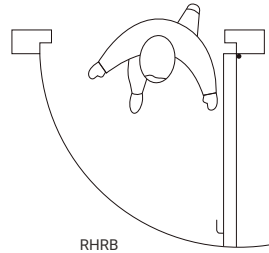
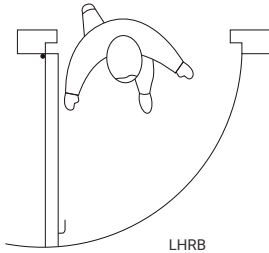

TYPE	CONCEALED PUSH PAD PANIC BOLT- LH	CONCEALED PUSH PAD PANIC BOLT- RH	PR-7085-AK SCREW PACK
PART CODE	CHL3549	CHL3708	CHL3716



Concealed Rod Crash Bar

Features:

- Range of horizontal cross bars and push bars are compliant to BS EN 1125.
- The cross bar is extruded aluminium in a silver satin, dark bronze, green or black anodised finish.
- The exit devices have nylon bushes for silent operation, with heavy duty lever springs for durable operation of the lever arms.
- Suitable for narrow and widestile doors.
- All fixings are concealed to ensure an aesthetically pleasing finish. The exit device houses do not exceed 120 x 186mm projection.
- Heavy duty lever springs for durable operation of lever arms
- Standard model suitable for doors of up to 1155mm wide & 2135 Height
- Extra wide model long crossbow suitable for doors up to 1220mm wide

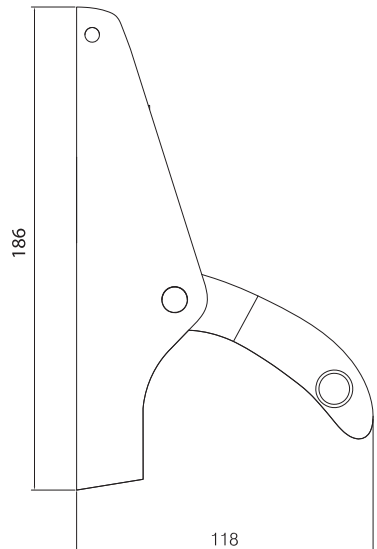

TYPE	7085 CVR EXIT DEVICE
PART CODE	CHL7085



Outside Locking Handle

Features:

- Key controlled
- Outside trim
- For use concealed exit devices.
- Uses screw in mortice cylinder with ms type cam.
- Not handed (field reversible).
- Covering a range of thickness doors from 46mm - 67mm.

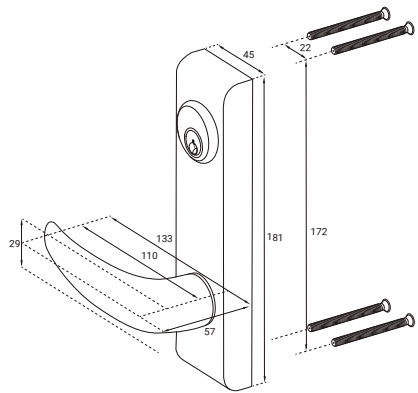
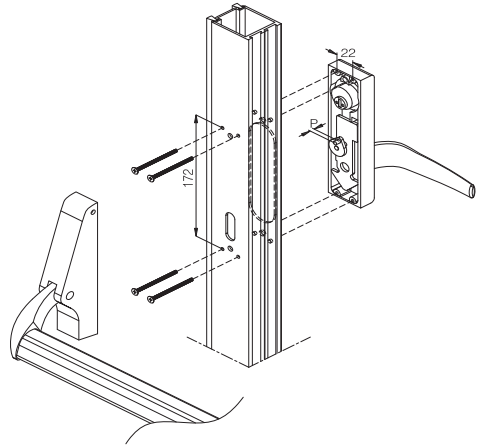

TYPE	OUTSIDE LOCKING
PART CODE	CHL745

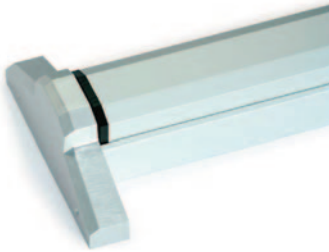

**Concealed Rod
Soft Touch Bar**

Features:

- Heavy duty lever springs and internal mechanism for durable, smooth operation.
- Plated steel and stainless steel internal components.
- 8.5mm diameter, steel locking rods.
- 16mm bolt throw
- Suitable for door widths as narrow as 700mm and 2135mm high.
- Extruded aluminium touch bar, anodized finish with coloured alloy end caps to match.

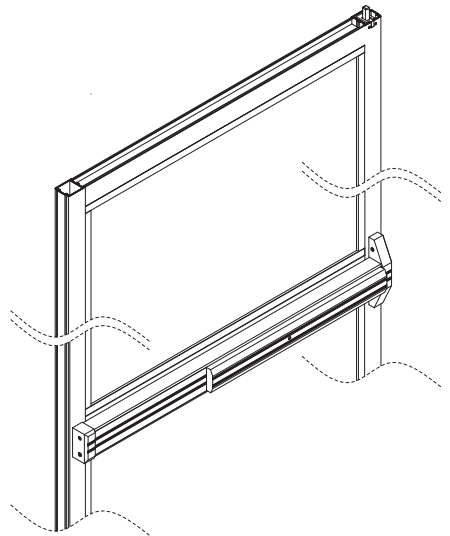

HAND OF DOOR

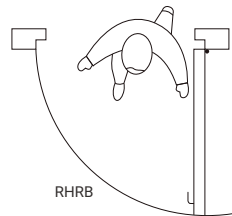
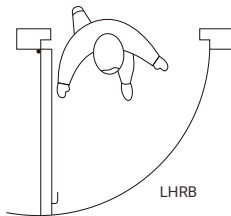

TYPE	STANDARD VERSION	48" VERSION
PART CODE	CHL7100	CHL7071



502A-B
Push Bar Panic latch

Features:

- Non-handed
- CE marked for safety
- Surface mounted
- 38mm wide footprint
- Suitable for doors with narrow stiles
- Microswitch version available
- Standard colours: silver, white with green cross bar and black with red cross bar
- Available in most RAL colours

Slimline Surface Mounted Hardware



501-B
Push Bar
Panic latch



512-B
Push Bar
Emergency
Exit Bolt with
Vertical
Pullman



502A-P
Push Bar
Emergency
Exit Bolt with
Horizontal
Pullman

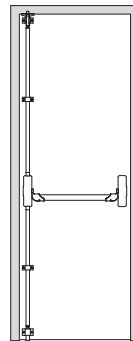

502A-B

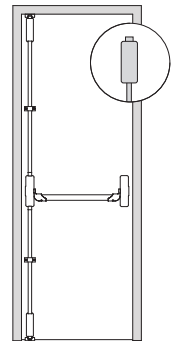

522-B

TYPE	502A-B PANIC	501-B PUSH BAR	512-B	502-P
PART CODE	CHL3492	CHL4353	CHL4584	CHL5452



Surface Mounted Panic Hardware



296
Reversible
Panic Latch



297
Single Door
Push Pad
With Latch

Features:

- Non-handed
- CE marked for safety
- Surface mounted
- 38mm wide footprint
- Suitable for doors with narrow stiles
- Microswitch version available
- Standard colours: silver, white with green cross bar and black with red cross bar
- Available in most RAL colours

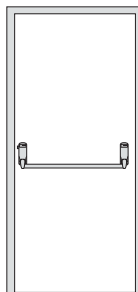

296

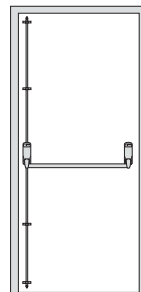

294

TYPE	294	296	297
PART CODE	CHL294	CHL296	CHL297

DOOR HANDLES



Handles

MEASURING GUIDE

STRAIGHT PULL HANDLE

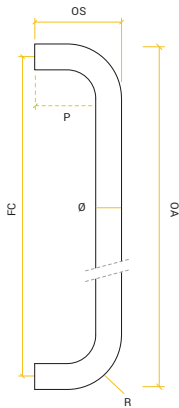

GUARDSMAN PULL HANDLE

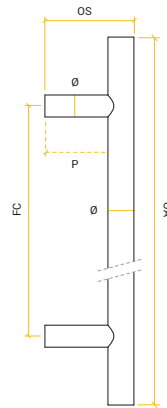

MITRED PULL HANDLE

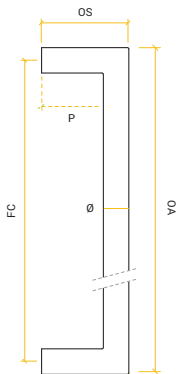

CRANKED PULL HANDLE

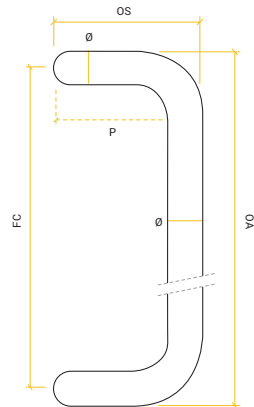

- Fixing Centres - FC
- Overall Length - O/A
- Projection - P
- Offset Size - OS
- Diameter - \varnothing

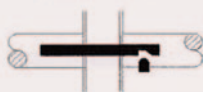

CHL1 - Back to back fixing for 30mm to 55mm thick metal and timber doors
Thread-M12 (M6 grub screw)
Hole prep-13mm dia
(CHL1.100) For doors 56mm to 70mm thick. (CHL1.120) For doors 71mm to 90mm thick



CHL2 - Back to back fixing for glass doors; complete with nylon washers and sleeves to protect the glass. Thread-M12 (M6 grub screw) Hole prep-15mm dia



CHL3 - CSK head machine screw for bolt through fixing single handles onto metal and timber doors. Thread-M12 Hole prep-13mm dia

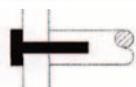

CHL4 - Stainless steel head decorative bolt for bolt through fixing single handles onto metal and timber doors. Thread-M12 Hole prep-13mm dia

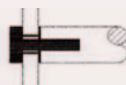

CHL5 - Stainless steel head decorative bolt for bolt through fixing single handles onto glass doors; c/w nylon washers and sleeves to protect the glass .. SSS or PDD finish.
Thread-M12 Hole prep-18mm dia



CHL6 - Hex head bolt with black plastic cover cap for single handles through metal and timber doors (please specify door thickness).
Thread-M12 Hole prep- 13mm dia

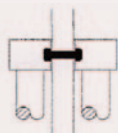

CHL7 - Up to 70mm thick doors
Handles fixed back to back by means of an M6 threaded stud secured with hex head nut internally and a dome head nut externally.
Thread-M6 Hole prep-9mm dia

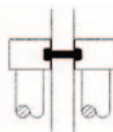

CHL8 - Glass doors
Handles fixed back to back by means of an M6 threaded stud secured with hex head nut internally and a dome head nut externally, complete with nylon washers and pads to protect the glass.
Thread-M6 Hole prep-12mm dia

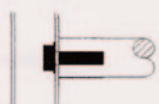

CHL9 - Single side (secret) fixing used when bolt through fixing is not suitable. i.e. when panic hardware is fitted to aluminium doors. Access to the glazing rebate is required prior to installation.
Thread-M12 Hole prep-13mm dia

Cranked Back to Back Pull Handle



Features:

- 300mm c/c x 32mm Ø
- 425mm c/c x 32mm Ø
- 600mm c/c x 32mm Ø
- 900mm c/c x 32mm Ø
- Bespoke sizes available upon request
- Satin stainless steel finish
- Universal fixings for aluminium, composite, glass & timber doors.

Finishes:



SSS

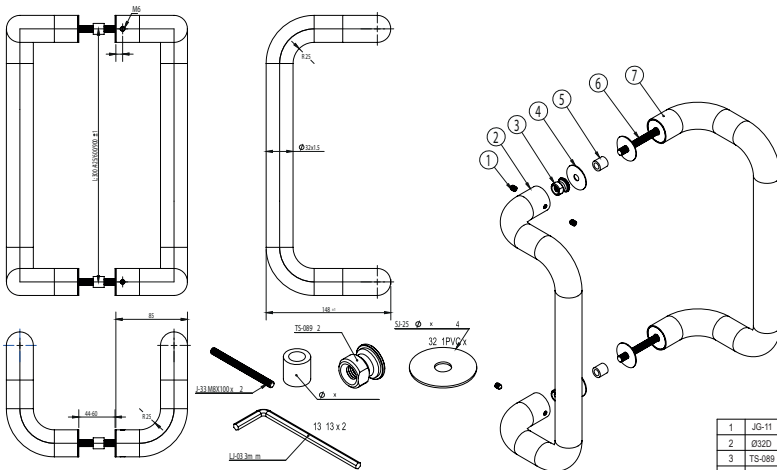

1	JG-11	Ø32	4
2	Ø32D	Ø32	1
3	TS-089		2
4	SJ-25	Ø32/8.6x1.0PVC	4
5		Ø13/8.2x13	2
6	J-33	M8x100	2
7	Ø32D	Ø32	1

SIZE	300 x 32mm	425 x 32mm	600 x 32mm	900 X 32MM
PART CODE	CHL150	CHL200	CHL250	CHL300



Semi Circular Back to Back Pull Handle

Features:

- 300mm c/c x 32mm Ø
- Bespoke sizes available upon request
- Satin stainless steel finish
- Universal fixings for aluminium, composite, glass & timber doors.

Finishes:

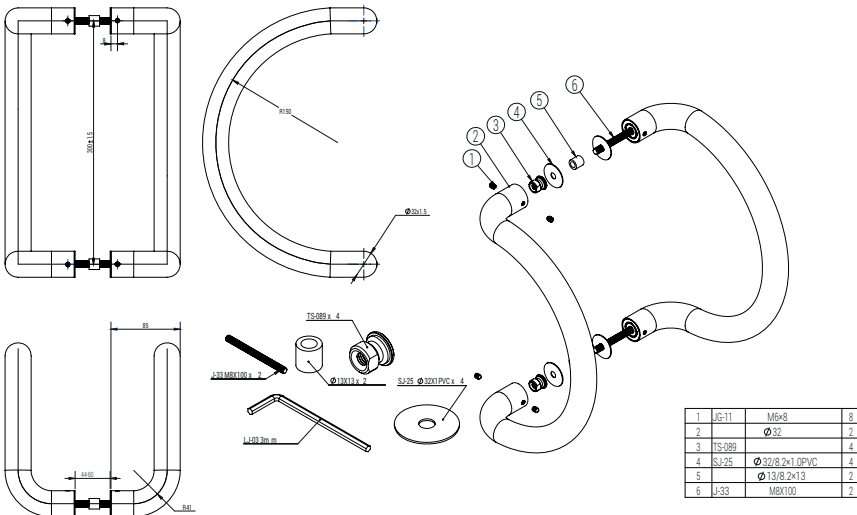

SIZE	300 x 32mm
PART CODE	CHL400

Powder coated options are available in most RAL colours - Enquire today

Handles

PULL HANDLES



Full Height Back to Back Pull Handle

Features:

- Supplied with 3000mm c/c x 38mm ø pole
- Complete with concealed cranked fixing brackets - To allow poles to be cut down, if required.
- Satin stainless steel finish.
- Universal fixings for aluminium, composite, glass & timber doors.
- Cranked Bracket - 108mm x 45mm x 40mm

Finishes:



Comes with Cranked Fixing Brackets

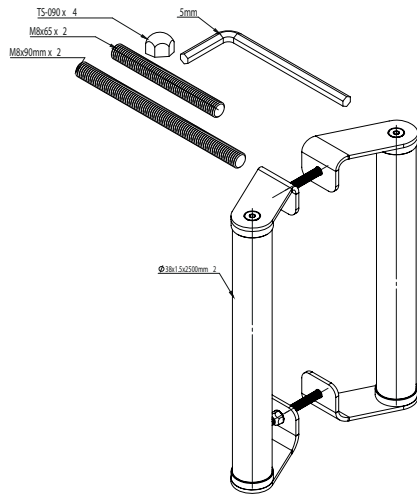
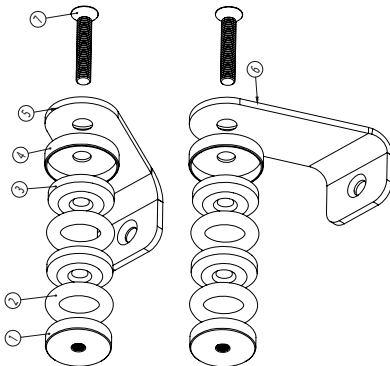

SIZE	3000 x 38mm	BRACKETS ONLY
PART CODE	CHL550	CHL550CB

Handles

PULL HANDLES

Guardsman T Bar Back To Back Pull Handle

Features:

- 900mm c/c x 32mm ø
- Wide range of sizes available upon request
- Satin stainless steel finish
- Universal fixings for aluminium, composite, glass & timber doors.

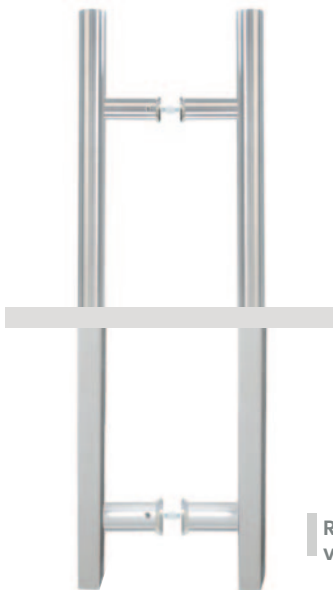

Rectangular version upon request



Offset pillar version available

1	ø32	2
2	JG-09	M6x6
3	TS-089	
4		M6
5	J-33	Ø 13xØ 2x13
6	SJ-23	Ø 25xØ 2x1.0PVC

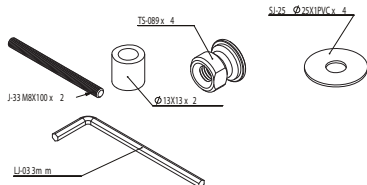
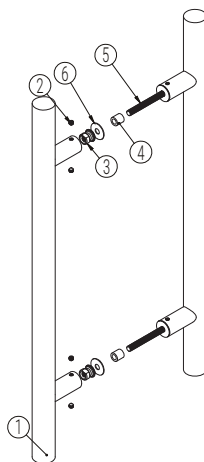
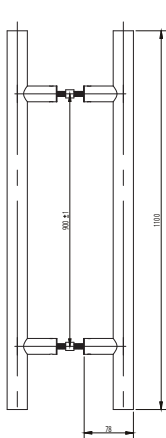
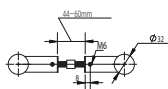

SIZE	900 X 32MM STRAIGHT T BAR	900 X 32MM CRANKED T BAR
PART CODE	CHL450	CHL500

ACCESS CONTROLS



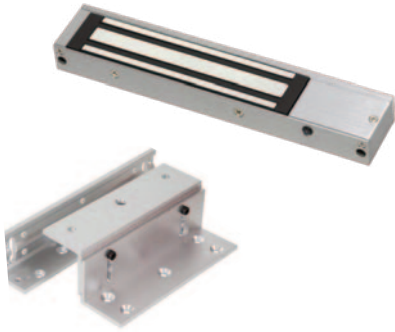

**Slimline Mag Lock
With Z&L Brackets**

Product Overview:

- Operating voltage: 12/24 VDC
- Current draw: 500mA/12VDC; 250mA/24VDC (at temperature 20°C)
- Operating temperature: -10-55°C(14-131°F)
- Humidity: 0-95% non-condensing.
- Holding force: Up to 600 lbs(272 Kg)
- Dimensions:
 - Magnet:(L) 250, (W) 42, (D) 26 mm
 - Armature plate:(L) 185, (W) 38, (D) 12 mm
 - Mounting plate:(L) 250, (W) 25, (D) 5 mm
- Net Weight: 2.0 Kg

Features:

- High reliability
- Aluminium anodized casing
- MOV provides spike and surge protection
- Dual voltage 12 or 24 VDC (selectable) Single voltage only 12 VDC (10002BZ)
- Anti-Residual magnetism function

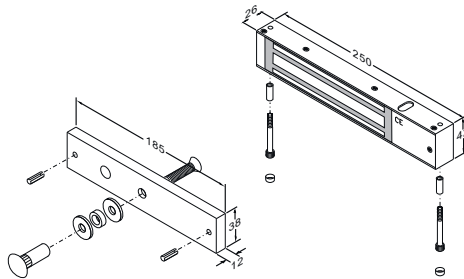

■ LZ - NH300N

■ EM - 1000LZ

■ LZ - 300N

■ LZ - 300BZ (For 10002BZ)

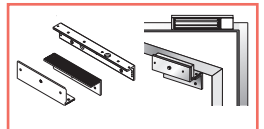
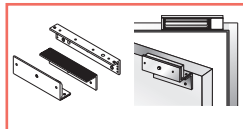
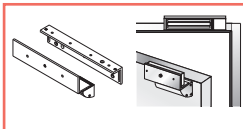
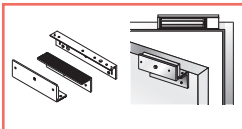

TYPE	SLIMLINE 1000-1	Z & L BRACKETS ONLY
PART CODE	CHL3206	CHL3608

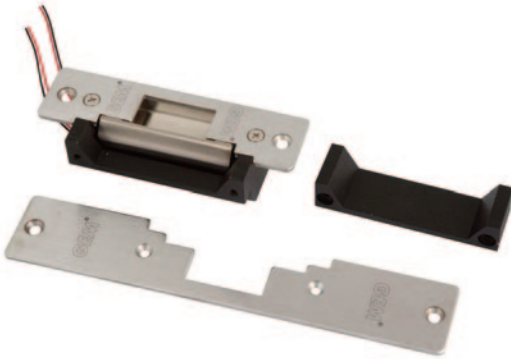

Universal 12/24V DC Electric Strike

Features:

- Power Input: 12 V DC (24V DC available by special order)
- Voltage Tolerance: $\pm 15\%$
- Current Draw: 0.25 A@12 VDC; 0.15 A@24 VDC (at temperature 20°C)
- Sensor Switch monitored output (GK-310M), Rating 2A@125V, indicates the lockset locked or unlocked status
- Operating Temperature: -10-45°C
- Humidity: 0-95% non-condensing
- Lock's surface Temperature (when the power is on): \leq current temperature +20°C
- 2000 LBS jaw strength pull testing
- Tested to 1,000,000 cycles
- Sub covers sold separate

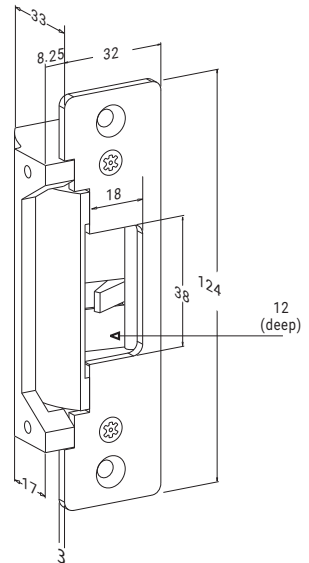

TYPE	ER310-1224 12/24VDC	SUB COVER 25MM	SUB COVER 50MM
PART CODE	CHL1562	CHL3713	CHL3715

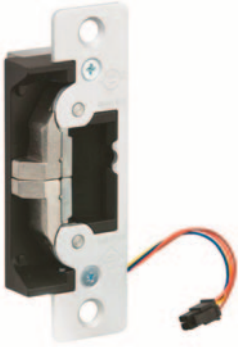

PART CODE	CHL3822
-----------	---------

Ultraline Strike

Features:

- Fail-Safe/Fail-Secure: Field selectable at time of installation.
- Case: Approximately 1" x 3-3/8" x 1-1/16" deep.
- Faceplate: Measures 1-1/4" x 6-7/8". 7430 has flat faceplate.
- Voltage: Field selectable to match power source of 12, 16, or 24 VAC/VDC.
- Finish Available: 626 Clear Anodized

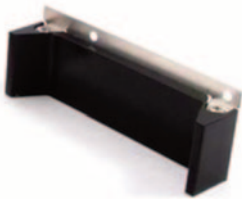

PART CODE	CHL3583
-----------	---------

Sub Cover

Features:

- This is a lip extension to suit the 7400 Ultraline Electric Strike



Digital Lock for Aluminium Doors

Features:

- Complete with 60mm Stainless Steel Latch
- Suitable for DDA applications
- New & improved clutch and coding chamber
- Clutched keypad handle
- Cycle tested to 100'000 operation
- Over 2000 code combinations available

PART CODE CHL3489



Digital Lock With Optional Holdback

Features:

- 1000+ combinations
- For internal or external applications
- Simple installation
- Optional holdback
- Suitable for 35-60mm thick doors
- Supplied complete with tubular latch and fixings

PART CODE CHL4134

PATCH FITTINGS



Glass

Standard Assembly Types

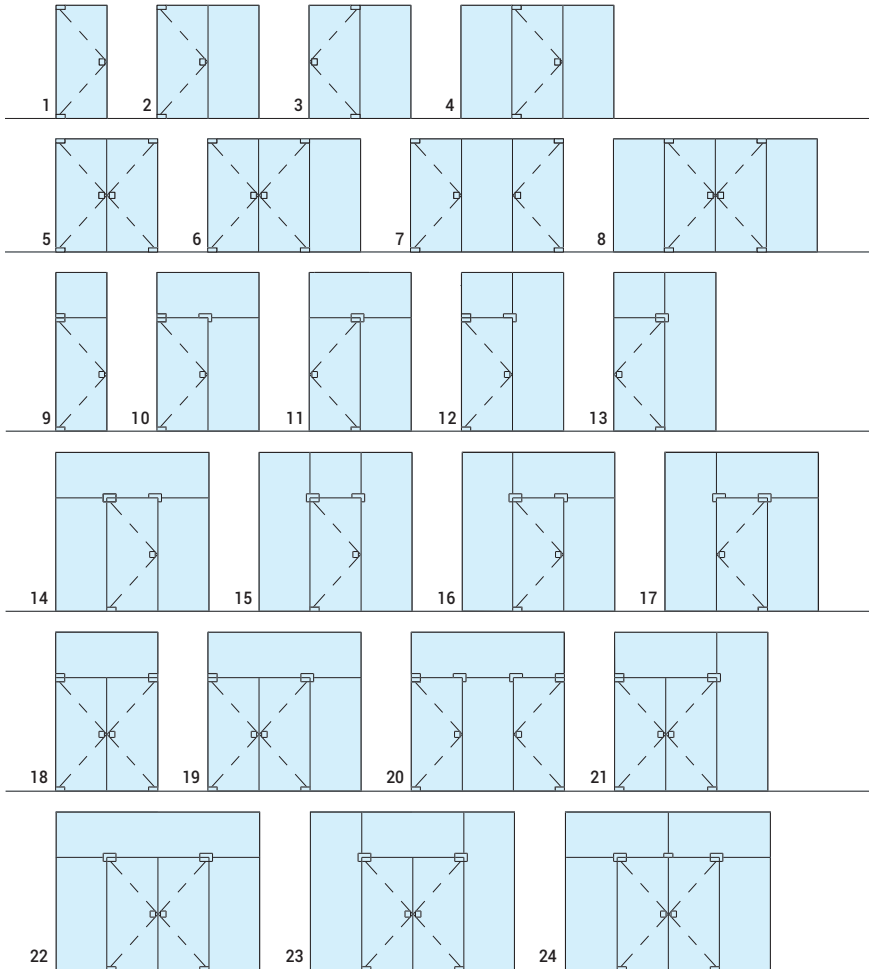



Top & Bottom Rail with Lock

Features:

- To suit glass thickness 10/12mm
- Rails can be cut to size
- 80mm / 100mm options available
- Finishes: SSS, SIM SS

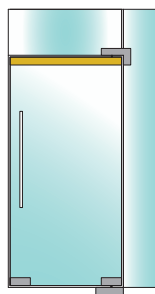
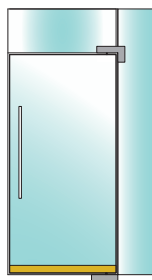
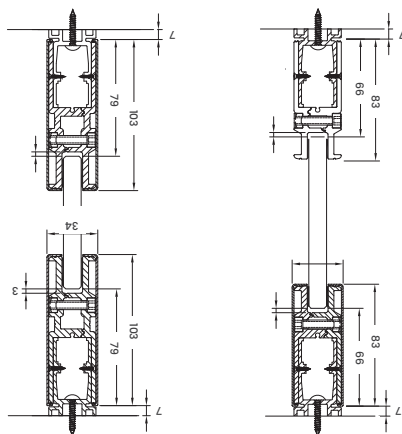

SIZE & TYPE	TOP RAIL 80MM	TOP RAIL 100MM	BOTTOM RAIL 80MM	BOTTOM RAIL 100MM
PART CODE	CHL6055	CHL4729	CHL6056	CHL5270

Glass

PATCH FITTING



Top Patch

Features:

- Top patch
- Variable pivot point to 55 to 65mm
- Quick release covers
- Finish: SSS 304
- Dimensions: 164 x 51 x 32mm
- For glass thickness of 10 or 12mm

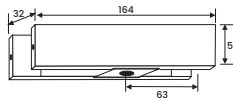
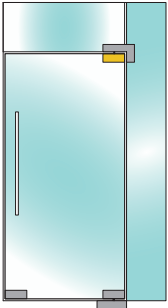

TYPE	TOP PATCH	TOP PATCH FOR TRANSOM CLOSER
PART CODE	CHL3450	CHL4566

Bottom Patch

Features:

- Bottom patch
- Variable pivot point to 55 to 65mm
- Compatible with ozone floor spring fs11400
- Quick release covers
- Base material casting: aluminium alloy
- Finish: SSS 304
- Dimensions: 164 x 51 x 32mm

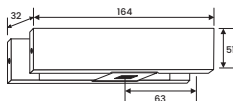

TYPE	BOTTOM PATCH
PART CODE	CHL3451

Glass

PATCH FITTING



Over Panel & Side Panel Patch

Features:

- Connects over panel & side panel with Top patch
- Pivot pin 15mm diameter
- Adjustable pivot point 55 to 65mm
- Quick release covers
- Finish: SSS 304
- Dimensions: 218 x 52 x 52mm

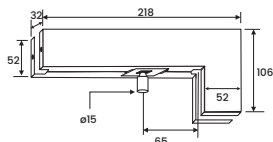
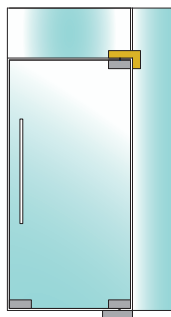

PART CODE CHL3452



Over Panel & Side Panel Strike Box

Features:

- Over panel and side panel connector patch with strike insert for opl-1
- Quick release covers
- Finish: SSS 304
- Dimensions: 218 x 52 x 32mm

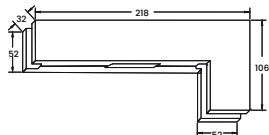
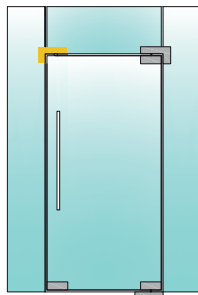

PART CODE CHL5631

Glass

PATCH FITTING



Centre Lock

Features:

- Centre Patch Lock
- With a Euro Profile Cylinder and Strike Box
- Dead Bolt Projection 15mm (Single Throw)
- Three High Security Computer Keys
- Base material casting: Aluminium Alloy
- Quick release covers
- Finish: SSS 304
- Dimensions: 164 x 52 x 32mm

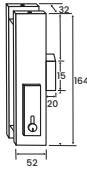
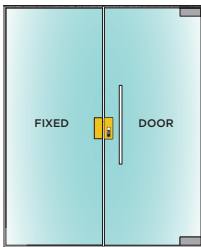

PART CODE CHL3454



Centre Strike

Features:

- Strike box accepts OPL-2A dead bolt
- Base material casting: Aluminium alloy
- Quick release covers
- Finish: SSS 304
- Dimensions: 164 x 52 x 32mm

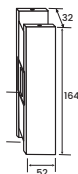
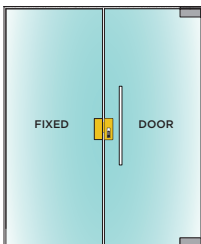

PART CODE CHL3455



Stainless Steel Top Pivot

Features:

- Stainless steel pivot
- Wear resistant pivot pin
- Pivot held in overhead structure
- Material: stainless steel grade 304
- Finish: SSS 304
- Dimensions: 105 x 25mm

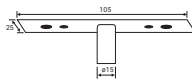
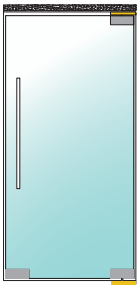

PART CODE CHL4572



Bottom Free Swing Pivot

Features:

- Mini floor hinge
- 360° Smooth door movement
- Suitable for OPF-3
- Finish: SSS 304
- Dimensions: 88 x 55mm

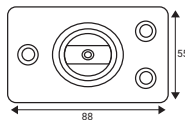
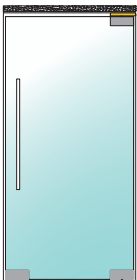

PART CODE CHL3651

Glass

PATCH FITTING



Corner Patch Lock Strike

Features:

- Corner patch lock
- With a Euro profile cylinder and strike plate
- Dead bolt projection 15mm (single throw)
- Three high security computer keys
- Base material casting: aluminium alloy
- Quick release covers
- Finish: sss 304
- Dimensions: 164 x 52 x 32mm

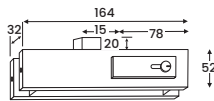
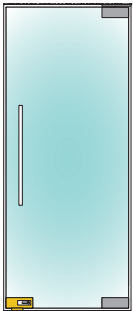

PART CODE	CHL3453
-----------	---------

**Cylinders are not included
with patch fittings.**

**For cylinders please go to
page 31**

WINDOW CONTROLS



Window Types

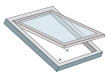

Roof Vent
Or Roof Light



Top-Hung
Awning



Bottom-Hung
Hopper

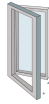

Side-Hung
Casement



Louvre
Jalousie Window

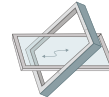

Horizontal
Pivot



Dome

Installation Examples

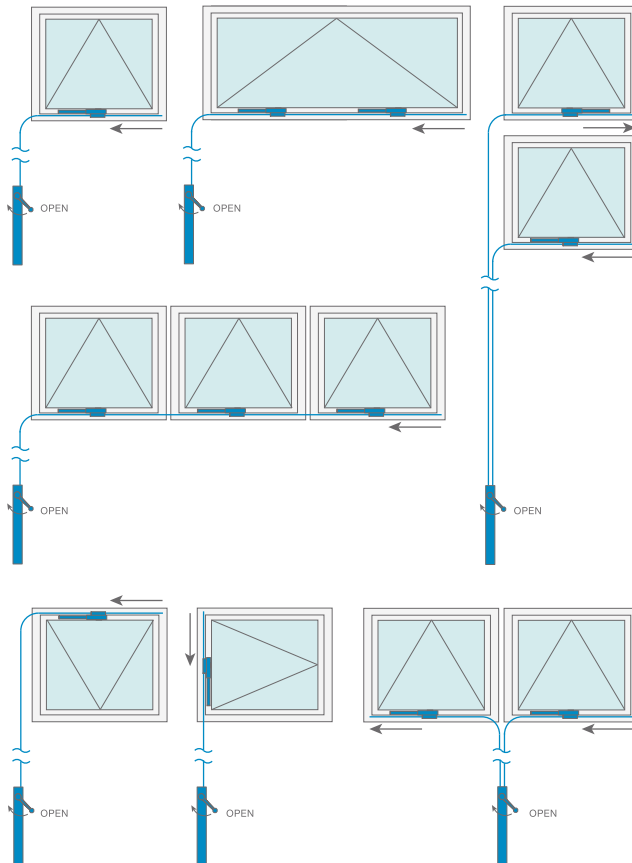

Window Control

Now available in anthracite grey

RAL 7016



MANUALLY OPERATED

Operator Handles

Features:

- For use with manual chain openers to operate high level windows
- Standard & Heavy duty options available
- Available in White, Grey, Anthracite Grey & Black

TYPE	FINISH	SIZE	PART CODE
MINI CHAIN OPENER	WHITE	45 X 88MM	CHL5229
MINI CHAIN OPENER	GREY	45 X 88MM	CHL6150
MINI CHAIN OPENER	BLACK	45 X 88MM	CHL6149
MIDI CHAIN OPENER	WHITE	45 X 385MM	CHL1136
MIDI CHAIN OPENER	GREY	45 X 385MM	CHL3543
MIDI CHAIN OPENER	BLACK	45 X 385MM	CHL3542
MAXI CHAIN OPENER	WHITE	90 X 150MM	CHL3421
MAXI CHAIN OPENER	GREY	90 X 150MM	CHL3544
MAXI CHAIN OPENER	BLACK	90 X 150MM	CHL4845



Chain Openers

Features:

- For use with manual operating handles to open high level windows
- Available as 250 or 380mm opening stroke (adjustable)
- Available in White, Grey, Anthracite Grey & Black

TYPE	WHITE 250MM	GREY 250MM	BLACK 250MM	WHITE 380MM	GREY 380MM	BLACK 380MM
PART CODE	CHL1446	CHL1042	CHL1041	CHL6148	CHL3493	CHL6146



Now available in
anthracite grey

RAL 7016

TYPE		FINISH	SIZE	PART CODE
CABLE CONDUIT	1	WHITE	3M	CHL1447
CABLE CONDUIT		GREY	3M	CHL3502
CABLE CONDUIT		BLACK	3M	CHL3501
3 PIECE SADDLE BRACKET	2	WHITE	-	CHL1550
3 PIECE SADDLE BRACKET		GREY	-	CHL6160
3 PIECE SADDLE BRACKET		BLACK	-	CHL5617
CABLE CONNECTOR	3	WHITE	-	CHL1382
CABLE CONNECTOR		GREY	-	CHL6158
CABLE CONNECTOR		BLACK	-	CHL5618
WIDE FIXING PLATE	4	WHITE	-	CHL2832
WIDE FIXING PLATE		GREY	-	CHL6161
WIDE FIXING PLATE		BLACK	-	CHL6162
NARROW FIXING PLATE	5	WHITE	-	CHL526
NARROW FIXING PLATE		GREY	-	CHL3499
NARROW FIXING PLATE		BLACK	-	CHL3498
CONTROL CABLE	6	-	3M	CHL1419
SWAGE TOOL	7	-	-	CHL1383
CONDUIT BEND FORMER	8	-	-	CHL2477

Electric Actuator Opener



Window Type;



Top-Hung Awning



Bottom-Hung Hopper

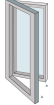

Side-Hung Casement

Features:

- 100-400mm opening stroke (adjustable)
- Suitable for most window types
- Double link chain (stainless steel)
- Supplied with 1.5m cable
- Available as 24 & 230V DC

Finishes:



GR, BK, WH

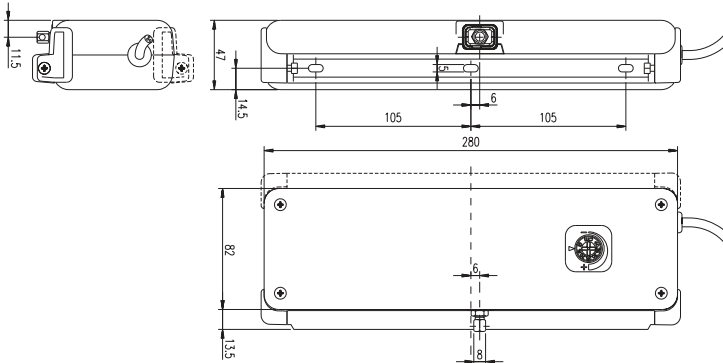

TYPE	ACK4 IN WHITE	ACK4 IN GREY	ACK4 IN BLACK
PART CODE	CHL2100	CHL3494	CHL2303



The U.K. specialists for the specification and supply of market leading door control products.

Established in 1995, Controls for Doors Ltd has earned the reputation for supplying a diverse range of the highest quality door hardware and electronic security products available in the UK market. Our aim is to provide the building owner with ultimate life cycle costing performance.

We ALSO provide the following heavy duty solutions, for specification and next day supply:

Heavy Duty Ironmongery

LCN Door Closers, Von Duprin and Rixson

Access Control

Securitron - Magnets & Keypads, Prastel and XPR, IGEM and Assa strikes

Entrance Accessibility

Ives & Glynn Johnson and Yale

Contact us



Controls for Doors Limited,
Venn Place,
Hayes Estate, Godstone
Road, Caterham,
Surrey. CR3 6SF
T: 01883 652652
F: 01883 652055
E: sales@cfdltd.com
www.controlsfordoors.com



Index

Door Closers

Transom Door Closer	9
Transom Accessories	10
Adjustable Power 2-4 & 2-5.....	11
Adjustable Power Guide Rail.....	12
Universal Floor Spring	13
Heavy Duty Universal Floor	14

Locks

Euro Profile Hook Lock.....	17
Round Cylinder Hook Lock.....	16
Euro Profile Deadlatch.....	19
Round Cylinder Deadlatch.....	18
High Security Hooklock.....	21
Narrow Style Sashlock.....	20
Lock Accessories.....	22
Aluminium Pad Handle.....	25
Paddle Handle.....	25
Lever Handle.....	25
Squared Flushbolt.....	24
Radius Flushbolt.....	24
Top Centre.....	26

Cylinders

Euro Single.....	31
Euro Double.....	31
Cylinder And Turn.....	32
3 Star.....	32
ABS 3 Star.....	33
Rim Cylinder.....	34
Threaded Cylinder.....	34

Panic Hardware

Concealed Rod.....	39
Concealed Rod Paddle.....	38
Concealed Rod Soft Touch.....	41
Outside Locking Handle.....	40
Surface Mounted.....	43
Slimline Surface.....	42

Pull Handles

Cranked Back To Back.....	47
Semi Circular.....	48
Full Height	49
Guardsman T Handle.....	50

Access Controls

Universal 12/24v.....	53
Slimline Mag Lock.....	52
Z & L Brackets.....	52
Ultraline Strike.....	54
Sub Cover.....	54
Digital Lock For Aluminium Doors.....	55
Digital Lock With Optional Hold Back.....	55

Patch Fittings

Top And Bottom Rail.....	58
Top And Bottom Rail With Lock.....	58
Top Patch.....	59
Bottom Patch.....	59
Over Panel & Side Panel Patch.....	60
Over Panel & Side Panel Strike Box.....	60
Centre Lock.....	61
Centre Strike.....	61
Stainless Steel Top Pivot.....	62
Bottom Free Swing Pivot.....	62
Corner Patch Lock Strike.....	63

Window Controls

Operator Handle.....	66
Chain Openers.....	66
Conduit.....	67
Cable.....	67
Conduit Tool.....	67
Saddle Clips.....	67
Connectors.....	67
Fixing Plates.....	67
Electric Actuator Opener.....	68



Controls for Doors Limited

T: 01883 652652 F: 01883 652055
E: sales@cfdltd.com www.controlsfordoors.com